

Article number: 20166B252BL

Description: Off-set baseplate clamps GN166-B25-2-BL
GN166

Measures

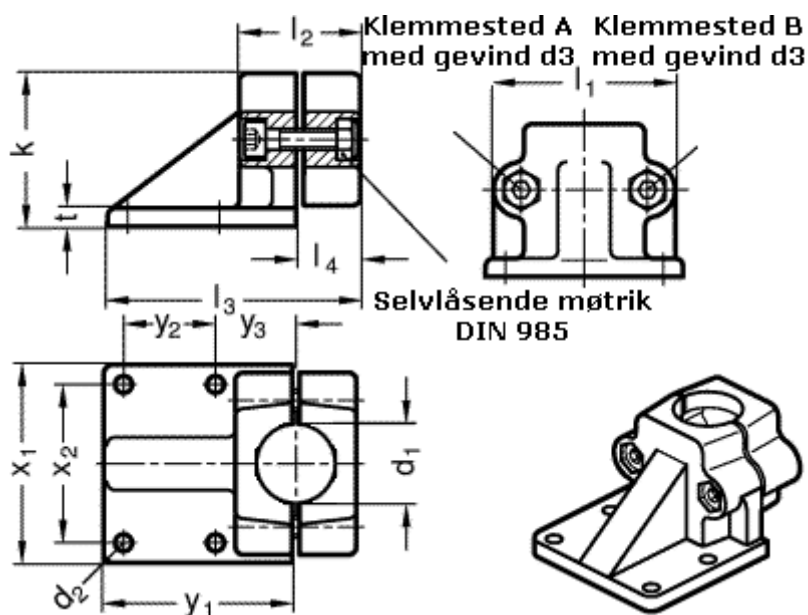

d1 = B25	t = 7
d2 = 7	x1 = 75
d3 = M 8	x2 = 60
k = 58	y1 = 72
l1 = 69	y2 = 35
l2 = 46	y3 = 30
l3 = 96	
l4 = 23	